











CABLE REELS - OVERVIEW

Part. number	Color	Material	Cable Diameter (mm)	Maximum Cable Length (m)	Dimensions mm							Weight without cable
					A	B	C	D	F	H	T	
HT-300	 Black	Sheet Metal	5,0	200	300	178	142	146	265	360	232	3,10 kg
5,5			150									
6,5			125									
10,0			50									
HT-380	 Black	Sheet Metal	12,0	n/a	380	178	142	175	300	450	230	5,30 kg
5,0			450									
5,5			375									
6,5			259									
HT-385	 Black	Sheet Metal	10,0	100	380	176	210	175	300	460	309	5,66 kg
5,0			700									
5,5			550									
6,5			400									
HT-485	 Black	Sheet Metal	12,0	75	460	178	210	175	350	545	290	7,60 kg
5,0			1000									
5,5			900									
6,5			650									
MP-HT-300	 Black	Sheet Metal	10,0	200	300	178	142	146	265	360	232	3,10 kg
5,0			150									
5,5			125									
6,5			50									
MP-HT-380	 Green	Sheet Metal	12,0	n/a	380	178	142	175	300	450	230	5,30 kg
5,0			450									
5,5			375									
6,5			259									
MP-HT-385	 Sand	Sheet Metal	10,0	100	380	176	210	175	300	460	309	5,66 kg
5,0			700									
5,5			550									
6,5			400									
MP-HT-485	 Sand	Sheet Metal	12,0	75	460	178	210	175	350	545	290	7,60 kg
5,0			1000									
5,5			900									
6,5			650									
R-105	 Black  Green  Sand	Sheet Metal	5,0	700	350	125	400	250	N/A	N/A	N/A	3,5 kg
5,5	500											
6,5	350											
10,0	150											
12,0	100											

HT-SERIES & MP-HT-SERIES MEASUREMENTS

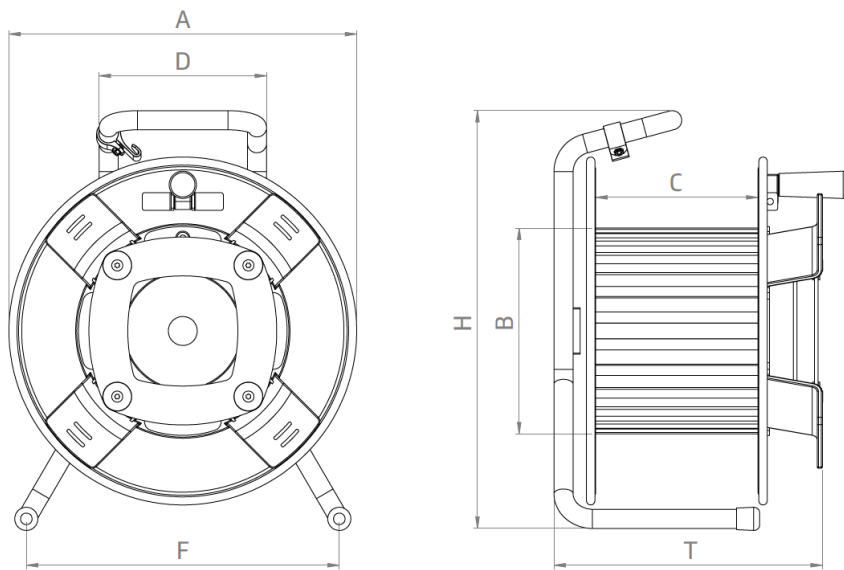

R-105 MEASUREMENTS

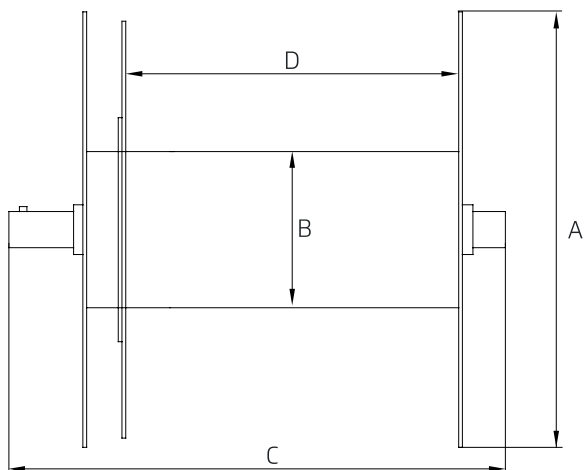

HT-SERIES



MP-HT-SERIES



R-105

